



TW

Buildex



Notes

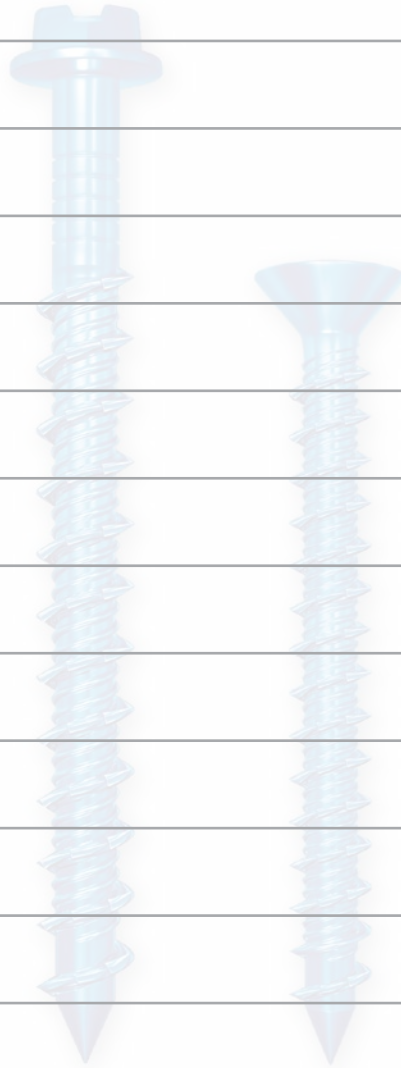

TABLE OF CONTENTS



TEKS Fastener Features.....	B 4
TEKS Self Drilling Fasteners.....	B 5
Light Duty Steel-To-Steel Applications.....	B 6
Medium Duty Steel-To-Steel Applications.....	B 8
Heavy Duty Steel-To-Steel Applications.....	B 11
Low Profile Architectural Metal Roof Clip Fasteners.....	B 14
Wood-to-Metal Fasteners.....	B 16
TEKS with Bonded Washer.....	B 19
TAPCON Concrete and Masonry Anchors.....	B 22
Tapcon+ Seismic and Cracked Concrete Screw Anchors.....	B 26
E-Z Drywall Anchors.....	B 31
Rock-On and Backer-On Fasteners.....	B 33
Gridmate BR Plastic Insulation Fasteners.....	B 35

TEKS[®] Fastening Features

FEATURES

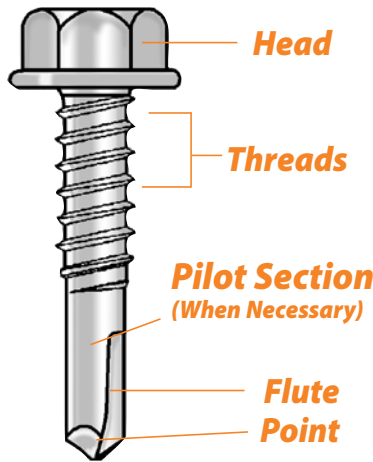

HEAD

Proper head style choice will ensure stability during driving, proper clamping and desired finished appearance.

THREAD FORM AND DIAMETER

The correct choice of thread form and diameter optimizes low installation torque with high pullout strength.

PILOT SECTION

The unthreaded portion of the point assures the drilling of the steel is completed before the threads begin tapping into the drilled hole.

POINT

The point is designed to efficiently remove material and precisely size the hole for the thread.

FINISH

Platings and coatings provide lubricity during drilling and tapping as well as corrosion resistance.

FASTENER DESCRIPTION AND BREAKDOWN — EXAMPLE

10 - **16** x **3/4"** **HWH** **Teks/3**
Nominal Screw Size Threads Per Inch Screw Length Head Style Drill PointType

Nominal Screw Sizes	
Thread Diameter	Decimal Equivalent
#6	.140
#7	.150
#8	.160
#9	.180
#10	.190
#11	.200
#12	.210
#13	.230
#14	.240
1/4	.250
#17	.286

Steel Gauge Chart		
Common Sheet Steel Gauges	Decimal Eq.	
	Inches	MM
30	.012	.30
28	.015	.38
26	.018	.45
24	.024	.61
22	.030	.76
20	.036	.91
18	.048	1.21
16	.060	1.52
14	.075	1.90
12	.105	2.65
1/8	.125	3.18
10	.134	3.42
3/16	.187	4.77
1/4	.250	6.36
1/2	.500	12.72

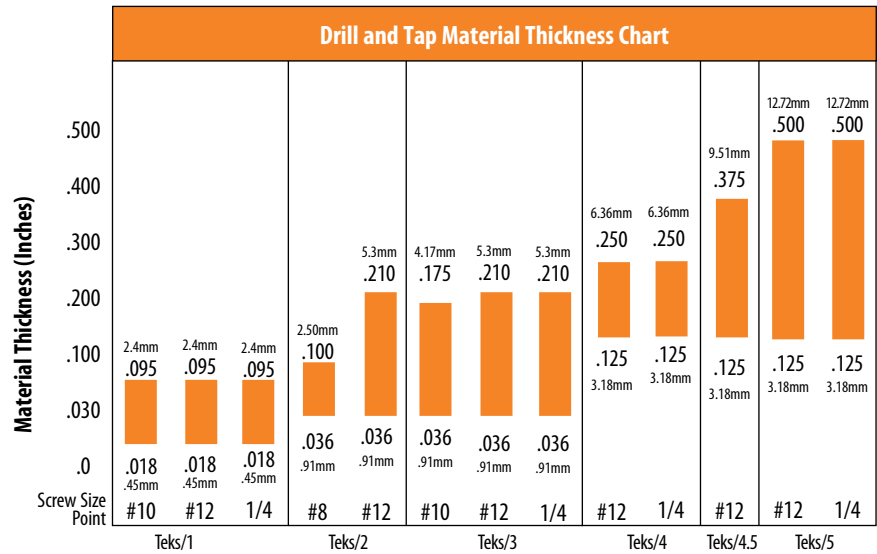

*Drill & tap capacities may vary with special feature designs. Refer to product reports for specifics.

TEKS[®] Self-Drilling Fasteners

*Preferred Most
by Electrical,
Decking, HVAC
and Metal
Building
Contractors*

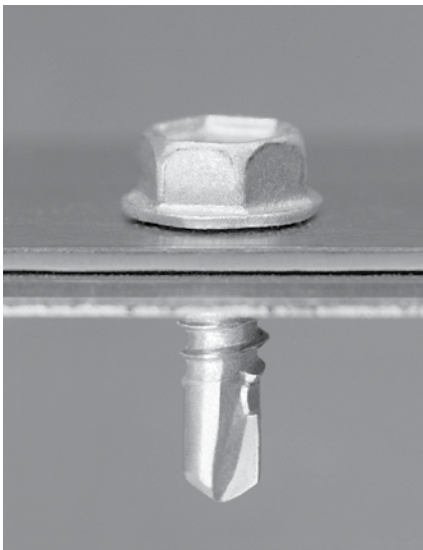

DESCRIPTION/ADVANTAGES

Light Duty Steel-To-Steel Applications—



- Sharp convex drill point has precise cutting edges to improve drill performance with less effort.
- Non-walking point provides fast material engagement.
- Unique point to thread design extrudes the metal preventing stripout.
- Point to thread design maximizes pullout performance and minimizes backout.
- Three head styles available to handle various applications.
- Climaseal[®] finish provides excellent corrosion resistance

SPECIFICATIONS

Diameter / Thread Form

8-18 and 10-16

Head Styles



Hex Washer Head
(HWH)



Socket Pan Head
(SP)



Modified Truss Head
(MTH)

Drill Point

Teks 2



Teks 3

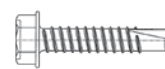

Finish

Type

Electro-zinc (EZ)
Climaseal[®] Coating (CL)
Climaseal[®]+ Coating (CL+)

Kesternich Results (DIN 50018, 2.0L)

3 cycles - 5% or less red rust
30 cycles - 10% or less red rust

Salt Spray Results (ASTM B117)

48 hours - 5% or less red rust
1000 hours - 10% or less red rust

Meets or exceeds Kesternich and Salt Spray Results of Climaseal[®] Coating (CL)

INSTALLATION INSTRUCTIONS

1. A standard screwgun with a depth sensitive nosepiece should be used to install Tekes. For optimal fastener performance, the screwgun should be a minimum of 4 amps and have a RPM range of 0-2000.
2. Adjust the screwgun nosepiece to properly seat the fastener.
3. New magnetic sockets must be correctly set before use. Remove chip build-up as needed.
4. The fastener is fully seated when the head is flush with the work surface.
5. Overdriving may result in torsional failure of the fastener or stripout of the substrate.
6. The fastener must penetrate beyond the metal structure a minimum of 3 pitches of thread.

TEKS Light Duty Steel-To-Steel Applications

APPLICATIONS

- Stitch roof deck and wall panel sidelaps.
- HVAC, electrical trim accessories to steel framing.
- Residential steel frame construction.
- Brick ties to steel framing.
- Track to stud and stud splicing.
- Hat channel to stud.

APPROVALS/LISTINGS

Factory Mutual (J.I. 2 X 9A2 AM)
ICC - ESR 1976

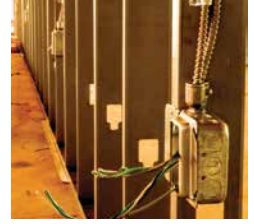

SELECTION CHART

TEKS® Fasteners

Finish: Electro-Zinc Plating.

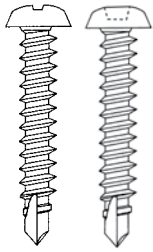

PART NUMBER	REFERENCE NUMBER	DESCRIPTION	HEAD STYLE	DRILL POINT	DRILL & TAP CAPACITY	MAX. MATERIAL ATTACHMENTS	BOX QTY	"X" PAK QTY	APPLICATIONS
2240	2240	8-18 x 1/2"	#2 SP	#2	.036-.100	.205	10,000		<ul style="list-style-type: none"> - HVAC, electrical trim accessories to steel framing - Residential steel frame construction - Track to stud - Hat channel to stud - Stud splicing
2250	2250	8-18 x 1/2"	MTH	#2	.036-.100	.205	10,000		
2280 ^x	2280	8-18 x 5/8"	#2 SP	#2	.036-.100	.330	10,000		
2330 ^x	2330 ^x	8-18 x 3/4"	#2 SP	#2	.036-.100	.455	10,000	1,000	
2360 ^x	2360 ^{xA}	8-18 x 1"	#2 SP	#2	.036-.100	.705	8,000	500	
2220	2220	8-18 x 1/2"	1/4" HWH	#2	.036-.100	.205	10,000		
2310 ^x	2310 ^{xA}	8-18 x 3/4"	1/4" HWH	#2	.036-.100	.455	10,000	1,000	
2365	2365 ^A	8-18 x 1"	1/4" HWH	#2	.036-.100	.705	8,000		

^P Available in P/A PAK ^x Available in X PAK

TEKS® Fasteners

Finish: Electro-Zinc Plating.

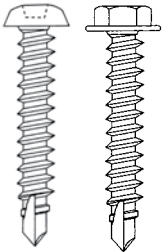

PART NUMBER	REFERENCE NUMBER	DESCRIPTION	HEAD STYLE	DRILL POINT	DRILL & TAP CAPACITY	MAX. MATERIAL ATTACHMENTS	BOX QTY	"X" PAK QTY	APPLICATIONS
2480	2480	10-16 x 3/4"	#2 SP	#3	.036-.175	.325	6,000		<ul style="list-style-type: none"> - Clips, duct straps, brick ties or accessories to steel framing
2490 ^x	2490 ^x	10-16 x 1"	#2 SP	#3	.036-.175	.575	5,000	500	
2495 ^x	2495 ^x	10-16 x 1-1/4"	#2 SP	#3	.036-.175	.825	4,000	250	
2400	2400	10-16 x 1/2"	5/16" HWH	#3	.036-.175	.150	6,000		
2460 ^x	2460 ^x	10-16 x 3/4"	5/16" HWH	#3	.036-.175	.325	6,000	500	
2510	2510	10-16 x 1"	5/16" HWH	#3	.036-.175	.575	5,000		

^P Available in P/A PAK ^x Available in X PAK

TEKS® Fasteners

Finish: Climaseal Coating.

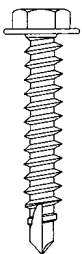

PART NUMBER	REFERENCE NUMBER	DESCRIPTION	HEAD STYLE	DRILL POINT	DRILL & TAP CAPACITY	MAX. MATERIAL ATTACHMENTS	BOX QTY	APPLICATIONS
1100 +	1128000	10-16 x 3/4"	5/16" HWH	#3	.036-.175	.325	5,000	<ul style="list-style-type: none"> - Clips, duct straps, brick ties or accessories to steel framing
1131000 +	1131000	10-16 x 1-1/2"	5/16" HWH	#3	.036-.175	.1075	3,000	
2220CL	2220CL	8-18 X 1/2"	1/4" HWH	#2	.036-.100	.205	10,000	

+ (CL+) Coating

PERFORMANCE TABLES

Sheet Steel Gauges

GAUGE NO.	12	14	16	18	20	22	24	26
Nominal Decimal Equivalent (Inch)	.105	.075	.060	.048	.036	.030	.024	.018

Pullout Values (Average Lbs. Ultimate)

FASTENER		STEEL GAUGE (Lbs.)							
DIA.	PT	26	24	22	20	18	16	14	12
#8	2	119	193	265	298	491	703	959	-----
#10-16	1	148	241	311	357	565	826	1111	1796
	3	124	208	266	299	499	708	967	1474
1/4	1	208	329	428	562	800	1151	-----	-----

Shear Values (Average Lbs. Ultimate)

FASTENER		STEEL GAUGE (Lapped)						
DIA.	PT	26	24	22	20	18	16	14
#8	2	294	496	560	740	1060	-----	-----
#10	1	398	584	659	884	1374	-----	-----
	3	-----	455	526	728	1266	1540	1552
1/4	1	511	849	885	1244	1764	-----	-----

Fastener Values

FASTENER (Dia-TPI)	TENSILE (Lbs. Min)	SHEAR (Avg. Lbs. Ultimate)	TORQUE (Min. in Lbs.)
8-18	1545	1000	42
10-16	1936	1400	61
10-24	2702	1500	65
12-14	2778	2000	92

The values listed are ultimate averages achieved under laboratory conditions and apply to Buildex manufactured fasteners only. Appropriate safety factors should be applied to these values for design purposes.

TEKS® Self-Drilling Fasteners

*The Best Point
Ever for Speed
and Consistency*

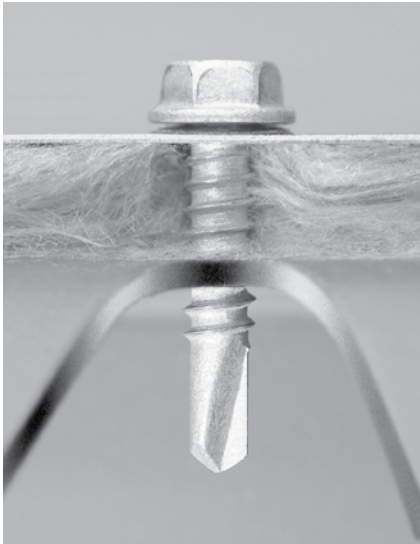

DESCRIPTION/ADVANTAGES

Medium Duty Steel-To-Steel Applications—



- Point has precise cutting edges to improve drill performance with less effort.
- Non-walking point provides fast material engagement.
- Point to thread design maximizes pullout performance and minimizes backout.
- Drills and taps in the broadest range of applications.
- Climaseal® finish provides excellent corrosion resistance and lower tapping torque.

SPECIFICATIONS

Diameter / Thread Form

10-16
12-14
1/4-14

Head Style



Hex Washer Head
(HWH)

Drill Point

Teks 2



Teks 3



Finish

Type

Electro-zinc (EZ)

Climaseal® Coating (CL)

Climaseal®+ Coating (CL+)

Kesternich Results (DIN 50018, 2.0L)

3 cycles - 5% or less red rust

30 cycles - 10% or less red rust

Meets or exceeds Kesternich and Salt Spray Results of Climaseal® Coating (CL)

Salt Spray Results (ASTM B117)

48 hours - 5% or less red rust

1000 hours - 10% or less red rust

INSTALLATION INSTRUCTIONS

1. A standard screwgun with a depth sensitive nosepiece should be used to install Teks. For optimal fastener performance, the screwgun should be a minimum of 6 amps and have a RPM range of 0-2500.
2. Adjust the screwgun nosepiece to properly seat the fastener.
3. New magnetic sockets must be correctly set before use. Remove chip build-up as needed.
4. The fastener is fully seated when the head is flush with the work surface.
5. Overdriving may result in torsional failure of the fastener or stripout of the substrate.
6. The fastener must penetrate beyond the metal structure a minimum of 3 pitches of thread.

TEKS Medium Duty Steel-To-Steel Applications

APPLICATIONS



- Roof deck to steel framing.
- Wall panel to girt.
- Duct work to steel framing.
- Accessories to steel framing
- Clip to steel framing.
- Retrofit framing.

APPROVALS/LISTINGS

Factory Mutual (J.I. 2 X 9A2 AM)
ICC - ESR 1976

DRILL POINTS

Teks 2



Teks 3



SELECTION CHART

TEKS® Fasteners

Finish: Climaseal Coating.

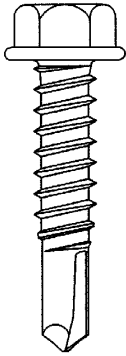

PART NUMBER	REFERENCE NUMBER	DESCRIPTION	HEAD STYLE	DRILL POINT	DRILL & TAP CAPACITY	MAX. MATERIAL ATTACHMENTS	BOX QTY	APPLICATIONS
1420	1134000	12-14 x 3/4"	5/16" HWH	#3	.036-.210	.270	5,000	- Duct work to steel framing
1136000	1136000 ^P	12-14 x 1"	5/16" HWH	#3	.036-.210	.520	4,000	- Accessories to steel framing
1590 +	1123000	12-14 x 1-1/2"	5/16" HWH	#2	.036-.210	.800	2,500	- Clip to steel framing
1620 +	1140000	12-14 x 2"	5/16" HWH	#3	.036-.210	1.450	2,000	
1820 +	1147000	1/4-14 x 3/4"	3/8" HWH	#3	.036-.210	.270	3,000	- Duct work to steel framing
1850 +	1149000	1/4-14 x 1"	3/8" HWH	#3	.036-.210	.520	2,500	- Accessories to steel framing
1150000 +	1150000	1/4-14 x 1-1/4"	3/8" HWH	#3	.036-.210	.550	2,000	- Clip to steel framing
1890 +	1152000	1/4-14 x 1-1/2"	3/8" HWH	#3	.036-.210	.800	2,000	
1920	1155000 ^P	1/4-14 x 2"	3/8" HWH	#3	.036-.210	1.450	1,500	
1950 +	1157000	1/4-14 x 3"	3/8" HWH	#3	.036-.210	2.450	1,000	
1304000	1304000	1/4-14 x 4"	3/8" HWH	#3	.036-.210	3.450	500	

+ (CL+) Coating

TEKS® Fasteners

Finish: Electro-zinc Plating.

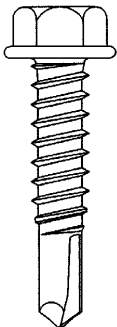

PART NUMBER	REFERENCE NUMBER	DESCRIPTION	HEAD STYLE	DRILL POINT	DRILL & TAP CAPACITY	MAX. MATERIAL ATTACHMENTS	BOX QTY	"A" PAK QTY	APPLICATIONS
113601	113601	12-14 x 1"	5/16" HWH	#3	.036-.210	.520	4,000		- Duct work to steel framing
112301	112301	12-14 x 1-1/2"	5/16" HWH	#3	.036-.210	.800	2,500		- Accessories to steel framing
114001	114001	12-14 x 2"	5/16" HWH	#3	.036-.210	1.450	2,000		- Clip to steel framing
114701	114701	1/4-14 x 3/4"	3/8" HWH	#3	.036-.210	.210	3,000		
114901 ^A	114901 ^A	1/4-14 x 1"	3/8" HWH	#3	.036-.210	.400		100	
115001	115001	1/4-14 x 1-1/4"	3/8" HWH	#3	.036-.210	.650	2,000		
115201 ^A	115201 ^A	1/4-14 x 1-1/2"	3/8" HWH	#3	.036-.210	.900		100	
115701	115701	1/4-14 x 3"	3/8" HWH	#3	.036-.210	2.400	1,000		

^A Available in A PAK

TEKS Medium Duty Steel-To-Steel Applications

PERFORMANCE TABLES

Sheet Steel Gauges

GAUGE NO.	12	14	16	18	20	22	24	26
Nominal Decimal Equivalent (Inch)	.105	.075	.060	.048	.036	.030	.024	.018

Pullout Values (Average Lbs. Ultimate)

FASTENER		STEEL GAUGE (Lbs.)								
DIA.	PT	26	24	22	20	18	16	14	12	3/16
#12	2	156	243	283	375	605	848	1181	1856	3520
	3	142	211	289	341	551	757	1063	1631	2998
1/4	3	141	231	293	346	613	880	1145	1858	4550

Shear Values (Average Lbs. Ultimate)

FASTENER		STEEL GAUGE (Lapped)							
DIA.	PT	26	24	22	20	18	16	14	12
#12	2	365	600	623	898	1370	1758	2138	2202
	3	-----	-----	-----	769	1358	1620	1970	1986
1/4	3	-----	-----	-----	930	1442	2100	2584	2650

Fastener Values

FASTENER (Dia-TPI)	TENSILE (Lbs. Min)	SHEAR (Avg. Lbs. Ultimate)	TORQUE (Min. in Lbs.)
12-14	2778	2000	92
1/4-14	4060	2600	150

The values listed are ultimate averages achieved under laboratory conditions and apply to Buildex manufactured fasteners only. Appropriate safety factors should be applied to these values for design purposes.

TEKS[®] Self-Drilling Fasteners

*First in
Performance!!
Over 30 Years of
Consistent Drilling*

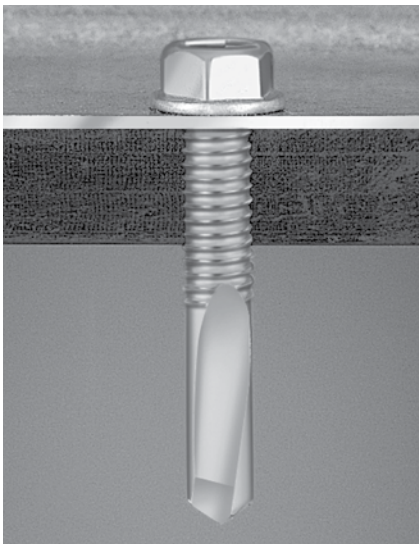

DESCRIPTION/ADVANTAGES

Heavy Duty Steel-To-Steel Applications— THE ORIGINAL SELF-DRILLERS FOR HEAVY DUTY APPLICATIONS

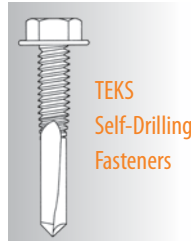

- Unique double fluted point has precise cutting edges to improve drill performance in 1/4" thru 1/2" steel.
- Engineered for fast drilling and smooth tapping with less effort.
- Climaseal[®] finish provides excellent corrosion resistance and lower tapping torque.
- Attachments up to 7.2" of material including 1/2" steel.
- 1/4" Diameter has notched threads to reduce tapping torque.

SPECIFICATIONS

Diameter / Thread Form

12-24
1/4-28

Head Styles



Hex Washer Head
(HWH)

Drill Point

Teks 4



Teks 5



NEW! Teks 5.0



Finish Type

Climaseal[®] Coating (CL)

Kesternich Results
(DIN 50018, 2.0L)

30 cycles - 10% or less red rust

Salt Spray Results
(ASTM B117)

1000 hours - 10% or less red rust

INSTALLATION INSTRUCTIONS

1. A standard screwgun with a depth sensitive nosepiece should be used to install Teks. For optimal fastener performance, the screwgun should be a minimum of 6 amps and have a RPM range of 0-2500. (Maximum 1800 RPM is recommended for Teks 5 fasteners)
2. Adjust the screwgun nosepiece to properly seat the fastener.
3. New magnetic sockets must be correctly set before use. Remove chip build-up as needed.
4. The fastener is fully seated when the head is flush with the work surface.
5. Overdriving may result in torsional failure of the fastener or stripout of the substrate.
6. The fastener must penetrate beyond the metal structure a minimum of 3 pitches of thread.

TEKS Heavy Duty Steel-To-Steel Applications

APPLICATIONS



Metal deck to structural steel or bar joist.



Clips to structural steel or bar joist.

Liner panels to structural steel or bar joist.



Accessories to structural steel or bar joist.

Longer length fasteners can be used in retrofit clip and sheet applications.

APPROVALS/LISTINGS

ICC ESR-3270
ICC ESR-1976
FM 3050495

DRILL POINTS

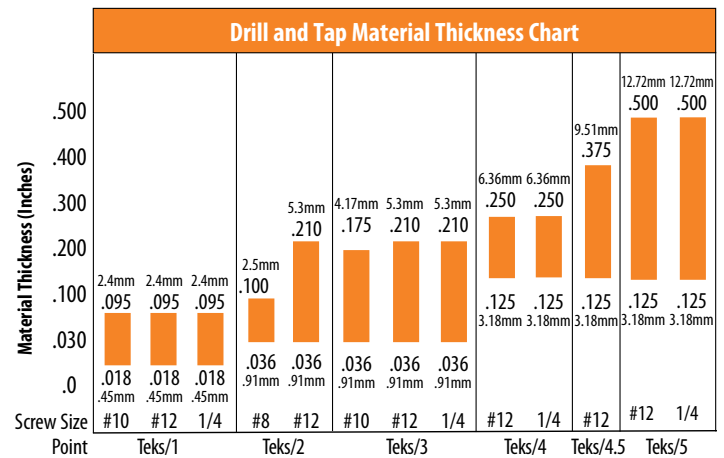

*Drill & tap capacities may vary with special feature designs. Refer to product reports for specifics.

SELECTION CHART

TEKS® Fasteners

Finish: Climaseal Coating.

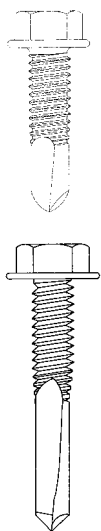

PART NUMBER	REFERENCE NUMBER	DESCRIPTION	HEAD STYLE	DRILL POINT	DRILL & TAP CAPACITY	MAX. MATERIAL ATTACHMENTS	BOX QTY	"P/X" PAK QTY	APPLICATIONS
1770057*	1770057	12-24 x 1-1/2"	5/16" HWH	#5	.125-.500	.625	250		- Metal deck, clips, linear panels or accessories to structural steel or bar joist
1650 ^P	1088000 ^P	12-24 x 7/8"	5/16" HWH	#4	.125-.250	.325	5,000	100	
1007000 ^{P*}	1006000 ^P	12-24 x 1-1/4"	5/16" HWH	#5	.125-.500	.375	4,000	100	
1007000 ^{P*}	1006000	12-24 x 1-1/4"	5/16" HWH	#5	.125-.500	.375	4,000	36	
1770000 ^{P*}	1001000	12-24 x 1-1/2"	5/16" HWH	#5	.125-.500	.625	2,500	100	
1772000 ^P	1072000 ^P	12-24 x 2"	5/16" HWH	#5	.125-.500	1.125	2,000	100	
1007057*	1007057	12-24 x 1-1/4"	5/16" HWH	#5	.125-.500	.375	2,000		- Retrofit clip and sheet applications
1774000*	1774000	1/4-28 x 3"	5/16" HWH	#5	.125-.500	2.150	1,000		
1075000	1075000	1/4-28 x 4"	5/16" HWH	#5	.125-.500	3.150	500		
1641000	1641000	1/4-28 x 5"	3/8" HWH	#5	.125-.500	4.150	250		
1431000	1431000	1/4-28 x 6"	3/8" HWH	#5	.125-.500	5.150	250		
1590000	1590000	1/4-28 x 8"	3/8" HWH	#5	.125-.500	7.150	150		

^P Available in P PAK ^B Available in X PAK * New TEKS 5.0

PERFORMANCE TABLES

Sheet Steel Gauges

GAUGE NO.	12	14	16	18	20	22	24	26
Nominal Decimal Equivalent (Inch)	.105	.075	.060	.048	.036	.030	.024	.018

Pullout Values (Average Lbs. Ultimate)

FASTENER		STEEL GAUGE (Lbs.)				
DIA.	PT	16	14	12	3/16	1/4
#12	4	----	----	1532	3485	4013
	4.5	----	----	1508	3865	4101
	5	----	----	1527	3701	3999
1/4	5	----	----	1507	3300	5059

Shear Values (Average Lbs. Ultimate)

FASTENER		STEEL GAUGE (Lapped)				
DIA.	PT	16	14	12	1/8	1/4
#12	4	----	----	2048	2030	----
	4.5	----	----	2641	2887	2897
	5	----	----	2650	2700	2762
1/4	5	1597	2005	2350	2792	3310

Fastener Values

FASTENER (Dia-TPI)	PT	TENSILE (Lbs. Min.)	SHEAR (Avg. Lbs. Ultimate)	TORQUE (Min. in Lbs.)
12-24	4	3020	2100	100
12-24	4.5	3165	2200	150
12-24	5	3020	2100	150
1/4-28	5	5577	3310	234

NOTE: Tek's fasteners are not categorized as structural bolts. Proper design criteria and strengths must be used for satisfactory application. The values listed are ultimate averages achieved under laboratory conditions and apply to Buildex manufactured fasteners only. Appropriate safety factors should be applied to these values for design purposes.

TEKS[®] Self-Drilling Fasteners

Low Profile Architectural Metal Roof Clip Fasteners



DESCRIPTION/ADVANTAGES

Low Profile Architectural Metal Roof Clip Fastener—

INCORPORATES THE ITW EXCLUSIVE PHILLIPS SQUARE-DRIV[®] ANTI-CAM-OUT SYSTEM

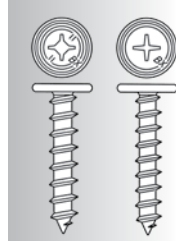

- #12 diameter utilizes the ITW exclusive Phillips Square-Drive[®] with patented interlocking components system.
 - Excellent installation stability.
 - Extended bit driver life.
 - Keeps the driver securely mated to the fastener during installation.
 - Hands-free installation.

- Fasteners are finished with a corrosion resistant coating. Teks 3 fasteners are available with Gray Spex[™] coating.
- Sharp convex drill point has precise cutting edges to improve drill performance with less effort.
- Low profile pancake head style ensures proper installation of metal roof panels.

SPECIFICATIONS

Diameter / Thread Form

12-14

Head Styles



Phillips Square-Drive
Pancake (PSP)

Drill Point

Teks 3



Finish

Type

Grey Spex

Kesternich Results
(DIN 50018, 2.0L)

15 cycles - 5% or less red rust

Salt Spray Results
(ASTM B117)

300 hours - 10% or less red rust

APPLICATIONS



Low profile architectural metal roof clips to steel purlin.

Low profile architectural metal roof clips to wood supports.

INSTALLATION INSTRUCTIONS

1. A standard screwgun with a depth sensitive nosepiece should be used to install Teks. For optimal fastener performance, the screwgun should be a minimum of 6 amps and have a RPM range of 0-2500.
2. Adjust the screwgun nosepiece to properly seat the fastener.
3. The fastener is fully seated when the head is flush with the work surface.
4. Overdriving may result in torsional failure of the fastener or stripout of the substrate.
5. The fastener must penetrate beyond the metal structure a minimum of 3 pitches of thread.
6. New magnetic sockets must be correctly set before use. Remove chip build-up as needed.

TEKS Low Profile Architectural Metal Roof Clip Fastener

SELECTION CHART

TEKS® Fasteners

Finish: Gray Spex Coating.



PART NUMBER	REFERENCE NUMBER	DESCRIPTION	HEAD STYLE	DRILL POINT	DRILL & TAP CAPACITY	MAX. MATERIAL ATTACHMENTS	BOX QTY	APPLICATIONS
1575553	1575553	12-14 x 1"	#2 PSD	#3	.036-210	.550	4,000	- Low profile architectural metal roof clip to steel purlin

PERFORMANCE TABLES

Sheet Steel Gauges

GAUGE NO.	12	14	16	18	20	22	24	26
Nominal Decimal Equivalent (Inch)	.105	.075	.060	.048	.036	.030	.024	.018

Pullout Values (Average Lbs. Ultimate)

FASTENER		STEEL GAUGE (Lbs.)							
DIA.	PT	26	24	22	20	18	16	14	12
#12	3	139	194	250	369	450	598	915	1500

Shear Values (Average Lbs. Ultimate)

FASTENER		STEEL GAUGE (Lapped)			
DIA.	PT	20 GAUGE	18 GAUGE	16 GAUGE	14 GAUGE
#12	3	923	1279	1657	1933

Fastener Values

FASTENER (Dia-TPI)	PT	TENSILE (Lbs. Min.)	SHEAR (Avg. Lbs. Ultimate)	TORQUE (Min. in Lbs.)
12-14	3	2652	2000	92

The values listed are ultimate averages achieved under laboratory conditions and apply to Buildex manufactured fasteners only. Appropriate safety factors should be applied to these values for design purposes.

TEKS® Wood to Metal Fasteners

**No Pre-Drilling,
Fast, Efficient
Attachment of
Wood-To-Metal**

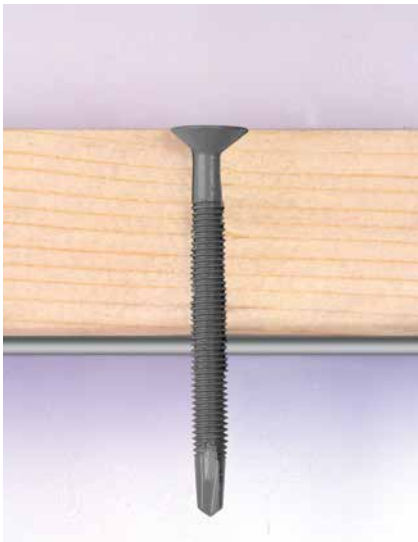

DESCRIPTION/ADVANTAGES

Wood-To-Metal Applications—

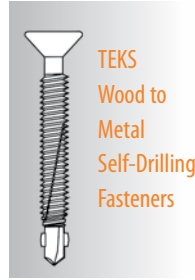

- Point has precise cutting edges to improve drill performance with less effort.
- Special winged fasteners ream a hole in wood preventing thread engagement during drilling.
- Wafer head design has a large bearing surface ideal for plywood.
- Flat head design countersinks and seats flush in wood.
- Gray Spex™ finish provides excellent corrosion resistance and lower tapping torque.
- Compatible with ACQ treated wood.

SPECIFICATIONS

Diameter / Thread Form

10-24
12-14
1/4-20

Head Styles

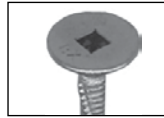

Socket Wafer Head (SW)



Philips Flat Head (PFH)

Drill Point

Teks 3

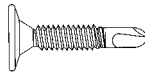

Teks 4



Finish

Type

Electro-zinc (EZ)
Grey Spex

Kesternich Results (DIN 50018, 2.0L)

3 cycles - 5% or less red rust
15 cycles - 5% or less red rust

Salt Spray Results (ASTM B117)

48 hours - 5% or less red rust
300 hours - 10% or less red rust

INSTALLATION INSTRUCTIONS

1. A standard screwgun with a depth sensitive nosepiece should be used to install Tekes. For optimal fastener performance, the screwgun should be a minimum of 6 amps and have an RPM range of 0-2500.
2. Adjust the screwgun nosepiece to properly seat the fastener.
3. Worn or damaged bit tip should be replaced.
4. The fastener is fully seated when the head is flush with the work surface.
5. Overdriving may result in torsional failure of the fastener or stripout of the substrate.
6. The fastener must penetrate beyond the metal structure a minimum of 3 pitches of thread.
7. All #10 diameter "Winged" parts must be driven into a minimum of 16 GA steel thickness.
8. All 1/4 and #12 diameter "Winged" parts must be driven into a minimum of 1/8" steel in order to break the wings consistently.

APPLICATIONS



Plywood roof and floor sheet to steel frames.

2 x 4 headers to steel frames.

Plywood fascia to steel frames.

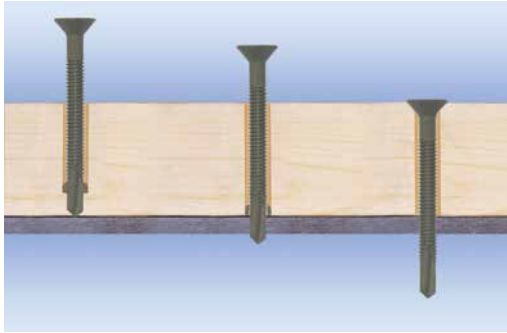

DRILL POINTS

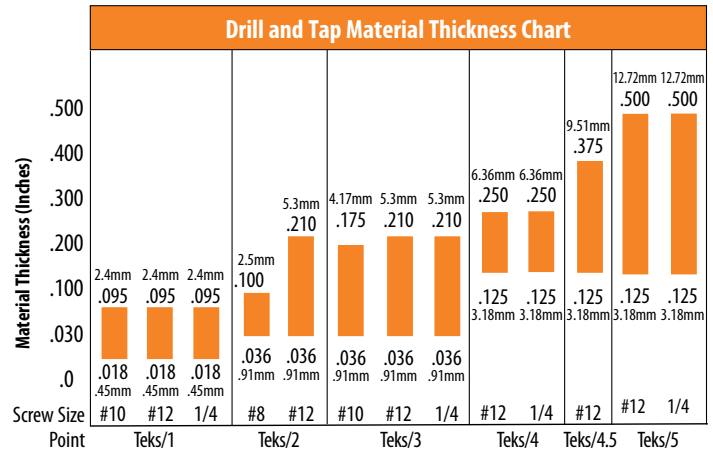
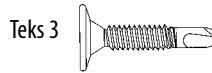

*Drill & tap capacities may vary with special feature designs. Refer to product reports for specifics.

SELECTION CHART

TEKS® Fasteners

Finish: Electro-zinc Plating. With Wings.



PART NUMBER	REFERENCE NUMBER	DESCRIPTION	HEAD STYLE	DRILL POINT	DRILL & TAP CAPACITY	WOOD ATTACHMENT RANGE	BOX QTY	"P" PAK QTY	"X" PAK QTY	APPLICATIONS
21730 ^P	21730 ^P	12-24 x 2"	#3 SW	#4	.125-.250	1/4" - 1"	2,000	100		- Plywood, 2 x 4's to steel framing
21750	21750 ^P	12-24 x 2-5/8"	#3 SW	#4	.125-.250	1/4"-1-1/2"	1,500		100	
21751 ^X	21751 ^X	12-24 x 3"	#3 SW	#4	.125-.250	1/4"-2"	1,000		100	

^P Available in P PAK ^X Available in X PAK

TEKS® Fasteners

Finish: Gray Spex Coating. With Wings.



PART NUMBER	REFERENCE NUMBER	DESCRIPTION	HEAD STYLE	DRILL POINT	DRILL & TAP CAPACITY	WOOD ATTACHMENT RANGE	BOX QTY	APPLICATIONS
1980	1096000	1/4-20 x 3"	#3 PFH	#4	.125-.250	3/4"-2"	1,000	- Plywood, 2 x 4's to steel framing
1092057	1092057	12-24 x 2-1/4"	#3 PFH	#4	.125-.250	3/4"- 1-3/8"	2,000	
1094056	1094056	12-24 x 2-3/4"	#3 PFH	#4	.125-.250	3/4"-2-5/8"	1,600	

TEKS Wood-To-Metal Applications

PERFORMANCE TABLES

Sheet Steel Gauges

GAUGE NO.	12	14	16	18	20	22	24	26
Nominal Decimal Equivalent (Inch)	.105	.075	.060	.048	.036	.030	.024	.018

Pullout Values (Average Lbs. Ultimate)

FASTENER		STEEL GAUGE Lbs.)									
DIA.	PT	26	24	22	20	18	16	14	12	3/16	1/4
#10-16	3	----	208	266	299	499	708	967	1474	----	----
#10-24	3	----	----	----	334	495	702	900	1570	3865	4101
#12	4	----	----	----	----	----	----	----	1508	4297	----
1/4	4	----	----	----	----	----	----	----	1803	----	----

Shear Values (Average Lbs. Ultimate)

FASTENER		STEEL GAUGE (Lapped)					
DIA.	PT	20	18	16	14	12	1/8
#10	3	728	1266	1540	1522	----	----
#12	4	----	----	----	----	2048	2030
1/4	4	----	----	----	----	2650	2820

Fastener Values

FASTENER (Dia-TPI)	TENSILE (Lbs. Min)	SHEAR (Avg. Lbs. Ultimate)	TORQUE (Min. in Lbs.)
10-16	1936	1400	61
10-24	2702	1500	65
12-24	3165	2200	150
1/4-20	3860	2700	168

The values listed are ultimate averages achieved under laboratory conditions and apply to Buildex manufactured fasteners only. Appropriate safety factors should be applied to these values for design purposes.

TEKS[®] with Bonded Washer

*For Weather-Tight
Sealing of Roof and
Wall Applications*

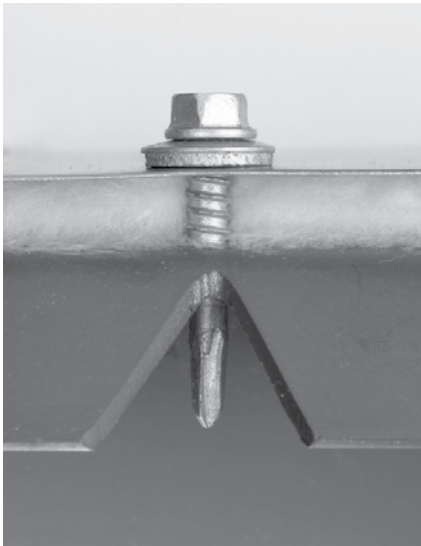

DESCRIPTION/ADVANTAGES

Metal Roof and Wall Applications—



- Vulcanized bonding of washer eliminates separation of EPDM from the metal backing.
- Dual sealing bonded washer prevents leaks.
- Climaseal[®] finish provides excellent corrosion resistance and lower tapping torque.
- Point has precise cutting edges to improve drill performance with less effort.
- Point to thread design maximizes pullout performance and minimizes backout.

SPECIFICATIONS

Diameter / Thread Form

10-16
12-14
12-24
1/4-14
1/4-28

Head Styles



Hex Washer Head with Bonded Washer (HWH)

Washer Style Galvanized (G-90)

Drill Point

Teks 1



Teks 2



Teks 3



Teks 5



NEW! Teks 5.0



Finish

Type

Climaseal[®] Coating (CL)

Climaseal[®]+ Coating (CL+)

Kesternich Results

(DIN 50018, 2.0L)

30 cycles - 10% or less red rust

Meets or exceeds Kesternich and Salt Spray Results of Climaseal[®] Coating (CL)

Salt Spray Results

(ASTM B117)

1000 hours - 10% or less red rust

INSTALLATION INSTRUCTIONS

1. A standard screwgun with a depth sensitive nosepiece should be used to install Teks. For optimal fastener performance, the screw gun should be a minimum of 6 amps and have an RPM range of 0-2500.
2. New magnetic sockets must be correctly set before use Remove chip build-up as needed.
3. Adjust the screwgun nosepiece to properly seat the fastener.
4. Overdriving may result in torsional failure of the fastener or stripout of the substrate.
5. The fastener must penetrate beyond the metal structure a minimum of 3 pitches of thread.

TEKS Metal Roof and Wall Applications

APPLICATIONS



- Roof panels to purlin or bar joist.
- Wall panels to girt.
- Mansard panel to structural.

PROPERLY SEATED WASHERS



DRILL POINTS

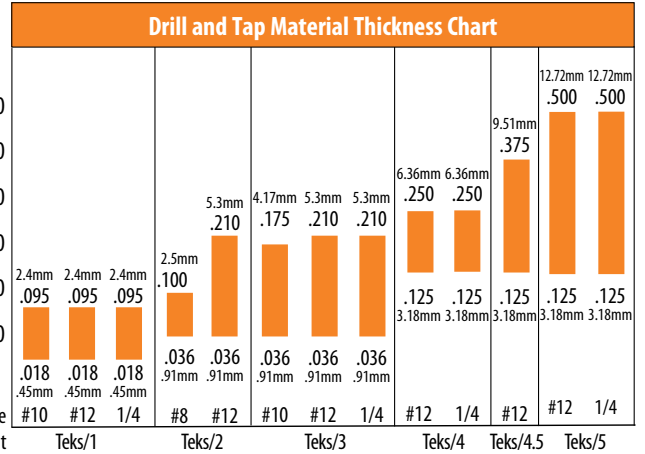
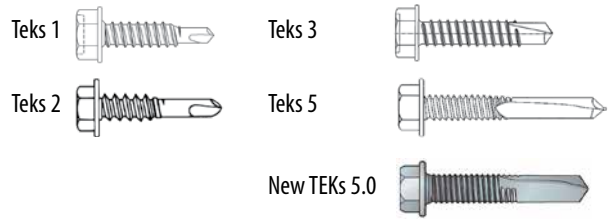

*Drill & tap capacities may vary with special feature designs. Refer to product reports for specifics.

SELECTION CHART

TEKS® w/Bonded Washer

Finish: Climaseal Coating.

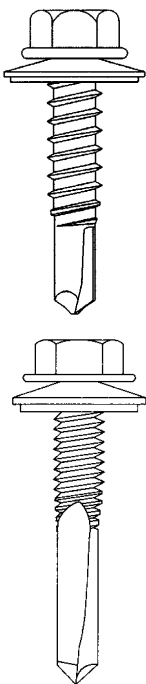

PART NUMBER	REFERENCE NUMBER	DESCRIPTION	HEAD STYLE	WASHER DIAMETER	DRILL POINT	DRILL & TAP CAPACITY	MAX. MATERIAL ATTACHMENTS	BOX QTY	APPLICATIONS
1005000 +	1005000	10-16 x 3/4"	5/16" HWH	9/16"	#3	.036-.175	.205	3,000	<ul style="list-style-type: none"> - Brick tie to steel framing - Mansard panel to steel framing - Roof panel to purlin - Stitch roof
1420W +	1009000	12-14 x 3/4"	5/16" HWH	9/16"	#3	.036-.210	.150	3,000	
1490W +	1011000	12-14 x 1"	5/16" HWH	9/16"	#3	.036-.210	.400	3,000	
1590W +	1404000	12-14 x 1-1/2"	5/16" HWH	9/16"	#2	.036-.210	.680	2,000	
1620W +	1016000	12-14 x 2"	5/16" HWH	9/16"	#3	.036-.210	1.330	1,500	
1790W +	1416000	1/4-14 x 7/8"	5/16" HWH	9/16"	#1	.018-.095	.260	3,000	
1850W +	1160000	1/4-14 x 1"	3/8" HWH	9/16"	#3	.036-.210	.280	2,500	
1890W		1/4-14 x 1-1/2"	3/8" HWH	9/16"	#3	.036-.210	.800	1,500	
1607000*	1021000	12-24 x 1-1/4"	3/8" HWH	9/16"	#5	.036-.210	1.280	2,500	
1670000*	1000000	12-24 x 1-1/2"	5/16" HWH	9/16"	#5	.125-.500	.255	2,500	
1672000*	1002000	12-24 x 2"	5/16" HWH	9/16"	#5	.125-.500	1.005	1,500	
1003000*	1003000	1/4-28 x 3"	5/16" HWH	9/16"	#5	.125-.500	2.030	1,000	
1647000*	1647000	1/4-28 x 5"	3/8" HWH	3/4"	#5	.125-.500	4.030	250	

+ (CL+) Coating * NEW TEKS 5.0

PERFORMANCE TABLES

Sheet Steel Gauges

GAUGE NO.	12	14	16	18	20	22	24	26
Nominal Decimal Equivalent (Inch)	.105	.075	.060	.048	.036	.030	.024	.018

Pullout Values (Average Lbs. Ultimate)

FASTENER		STEEL GAUGE (Lbs.)									
DIA.	PT	26	24	22	20	18	16	14	12	3/16	1/4
#10	3	124	208	266	299	499	708	967	1474	-----	-----
#12	2	156	243	283	375	605	848	1181	1856	3520	-----
	3	142	211	289	341	551	757	1063	1631	2998	-----
#12	4	-----	-----	-----	-----	-----	-----	-----	1532	3485	3844
	4.5	-----	-----	-----	-----	-----	-----	-----	1508	3865	4104
	5	-----	-----	-----	-----	-----	-----	-----	1527	3701	3999
1/4	1	208	329	428	562	800	1151	-----	-----	-----	-----
	3	141	231	293	346	613	880	1145	1877	4550	-----
	5	-----	-----	-----	-----	-----	607	918	1507	3300	5059

Shear Values (Average Lbs. Ultimate)

FASTENER		STEEL GAUGE (Lapped)									
DIA.	PT	26	24	22	20	18	16	14	12	1/8	1/4
#10	3	-----	445	526	728	1266	1540	1552	-----	-----	-----
#12	2	365	600	623	898	1370	1758	2138	-----	-----	-----
	3	-----	-----	-----	769	1358	1620	1970	1986	-----	-----
#12	4	-----	-----	-----	-----	-----	-----	-----	2048	2030	-----
	4.5	-----	-----	-----	-----	-----	-----	-----	2641	2887	-----
	5	-----	-----	-----	-----	-----	-----	-----	2650	2700	-----
1/4	1	511	849	885	1244	1764	-----	-----	-----	-----	-----
	3	-----	-----	-----	930	1442	2100	2584	2650	-----	-----
	5	-----	-----	-----	-----	-----	1597	2005	2350	2792	3310

Fastener Values

FASTENER (Dia-TPI)	TENSILE (Lbs. Min.)	SHEAR (Avg. Lbs. Ultimate)	TORQUE (Min. in Lbs.)
10-16	1936	1400	61
12-14	2778	2000	92
12-24	3020	2100	100
1/4-14	4060	2600	150
1/4-28	5577	3310	234

The values listed are ultimate averages achieved under laboratory conditions and apply to Buildex manufactured fasteners only. Appropriate safety factors should be applied to these values for design purposes.

TAPCON[®]

Concrete and Masonry Anchors

#1 CHOICE OF PROFESSIONALS
Tapcon[®]
 CHOIX #1 DES PROFESSIONNELS

Buildex.

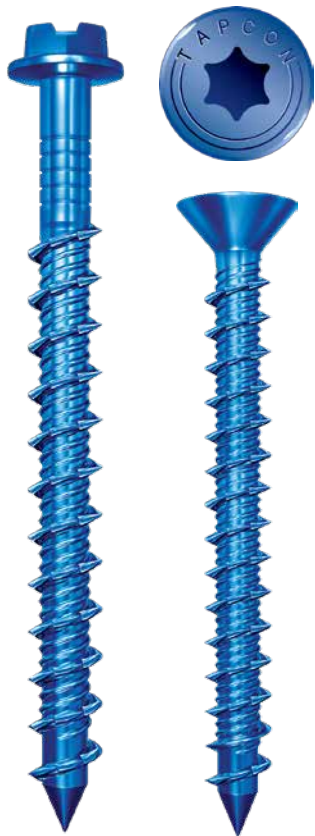

DESCRIPTION/ADVANTAGES

Light-To-Medium Duty Masonry Applications—

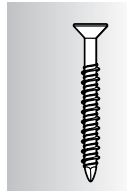

The “original masonry” anchor that cuts its own threads into concrete, brick, or block. Maximum performance is achieved because the Tapcon Anchor, the Condrive Installation Tool, and the carbide-tipped Tapcon Drill Bits are designed to work as a system. It is essential to use the Condrive tool and the correct drill bit to assure consistent anchor performance.

ADVANTAGES

- Fast installation ... drill a hole ... drive an anchor.
- Replaces small diameter expansion anchors, plugs and screws in light to medium duty applications.
- Packaged with one Tapcon “close tolerance” masonry drill bit per 100 anchors. Also available in bulk packaging.
- No need to pre-spot holes ... and no inserts are required.
- Available in 3/16" diameter up to 4" in length and 1/4" diameter up to 6" in length.
- Reversible and removable ... can be installed close to an edge.
- Compatible for use in ACQ treated wood.

Tapcon Anchors

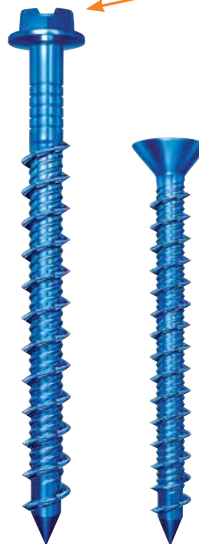

Hex Head style on Tapcon Anchors is available for majority of fixture anchoring needs

Climaseal[®] Coating is standard on all Tapcon anchors to provide extended corrosion resistance

Star Drive Head style is available when flush seating is necessary in countersink applications

Advanced Threadform cuts into masonry materials for greater pullout values

Lengths of Tapcon Anchors range from 1-1/4" to 4" in 3/16" and up to 6" in 1/4" diameters.

Nail-Type Point guides the anchor into the pre-drilled hole. Excellent for wood to concrete applications

SPECIFICATIONS

Diameter	3/16" and 1/4"	Head Style	Flat and Hex Head
Thread Form	Advanced Threadform Technology [®]	Point Type	Nail
		Finish	Blue Climaseal [®]

APPLICATIONS



Electrical junction boxes and conduit clips to masonry.

Wood headers and furring strips to masonry

HVAC strapping to masonry.

Plywood backer boards to masonry.

Exterior insulation systems to masonry.



INSTALLATION TOOL GUIDELINES

Tapcon Condrive Pro Installation Kit – A one-tool system engineered to work with all impact drivers, rotary hammers and hammer drills, the Tapcon Pro Installation Kit can drill and drive. The Condrive is designed to speed up anchor installation and enhance jobsite productivity. It features recessed hex drivers designed to significantly reduce over-torquing, head snapping and strip outs, allowing PROs to anchor with confidence and efficiency the first time, every time.

PREPARATION

1. Place correct Tapcon® drill bit in drill adapter and tighten set screw with hex key (included). For rotary hammer begin at Step 3.
2. Secure drill adapter into 3/8" – 1/2" chuck of hammer drill or into 1/4" impact hammer
3. Attach appropriate hex driver or Phillips bit to end of sleeve.

DRILL

4. Drill hole 1/4" deeper than depth of anchor embedment. (Min. embedment 1"). Remove dust from hole.

SLIDE

5. Slide sleeve over drill bit and snap into drill adapter

DRIVE

6. Insert anchor into the end of the sleeve, position fixture to be fastened and drive the Tapcon®

Buildex Condrive Tools are designed to specifically install Tapcon Anchors and to fit standard hammer drills.

APPROVALS/LISTINGS

ICC-ESR 1671 Masonry

ICC-ESR 2202 Concrete

INSTALLATION STEPS

Read instructions before using (installation)!



WARNING:

If there are any questions concerning proper installation, applications or appropriate use of this product, please call our Technical Services Department at 1-800-899-7890. Failure to follow these instructions can result in serious personal injury.

1. Select proper fastener – diameter / head style / length
 - a) Use selection chart to choose proper length.
2. Drill Hole – use selection chart to determine drill bit length and depth of hole
 - a) Choose appropriate drill bit based upon diameter of Tapcon Anchor.
 - b) Drill hole minimum 1/4" deeper than Tapcon Anchor to be embedded.

Minimum anchor embedment: 1"

Maximum anchor embedment: 1-3/4"
3. Drive Anchor



WARNING:

Failure to wear safety glasses with side shields can result in serious personal injury. Always wear ANSI compliant eye protection (ANSI Z87.1-2003).



WARNING:

Using the wrong size drill bit will affect performance values and may cause failure.

HEAD STYLES

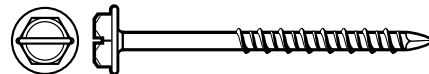

3/16" diameter has a 1/4" slotted hex washer head (HWH)

1/4" diameter has a 5/16" slotted hex washer head (HWH)



3/16" diameter uses a #2 Star Drive Head (FH)

1/4" diameter uses a #3 Star Drive Head (FH)

Tapcon Concrete and Masonry Anchors

SELECTION CHART

Tapcon Anchors 3/16" Diameter



DESCRIPTION	PART NO. 1/4" HWH 10 PK	PART NO. STAR DRIVE 10 PK *	PART NO. 1/4" HWH 25 PK	PART NO. STAR DRIVE 25 PK *	PART NO. 1/4" HWH 100 PK *	PART NO. STAR DRIVE 100 PK *	PART NO. 1/4" HWH 150 PK	PART NO. STAR DRIVE 150 PK *	PART NO. 1/4" HWH 225 PK	PART NO. STAR DRIVE 225 PK *	FIXTURE THICKNESS	STRAIGHT SHANK DRILL BIT PART NO.	DRILL BIT DESCRIPTION	CASE QTY *	BULK QTY
3/16" x 1-1/4"	BX51002	BX51070	BX51004	BX51072	3010 ^{BK}	3110 ^{BK}			24500C		0 - 1/4"	7200	5/32" x 3-1/2"	1000	3,000
3/16" x 1-3/4"	BX51008	BX51076	BX51010	BX51078	3020 ^{BK}	3120 ^{BK}			24505C		0 - 3/4"	7200	5/32" x 3-1/2"	1000	3,000
3/16" x 2-1/4"	BX51014	BX51082	BX51016	BX51084	3030 ^{BK}	3130 ^{BK}				24560C	1/2" - 1-1/4"	7210	5/32" x 4-1/2"	1000	2,000
3/16" x 2-3/4"	BX51020	BX51088	BX51022	BX51090	3040 ^{BK}	3140 ^{BK}					1" - 1-3/4"	7210	5/32" x 4-1/2"	1000	1,500
3/16" x 3-1/4"	BX51026	BX51094	BX51028	BX51096	3060 ^{BK}	3160 ^{BK}				24507C	1-1/2" - 2-1/4"	7220	5/32" x 5-1/2"	1000	1,000

Tapcon Anchors must be installed using all Buildex system components (Tapcon Anchors, Condrive Tools and Tapcon Drill Bits) in order to qualify for ITW Buildex system support.

* 3/16" Star Drive Tapcons use T-25 bit part#28000C

^{BK} Available in Bulk Pack Qty

Tapcon Anchors 1/4" Diameter



DESCRIPTION	PART NO. 5/16" HWH 10 PK	PART NO. STAR DRIVE 10 PK *	PART NO. 5/16" HWH 25 PK	PART NO. STAR DRIVE 25 PK *	PART NO. 5/16" HWH 100 PK *	PART NO. STAR DRIVE 100 PK *	PART NO. 5/16" HWH 150 PK	PART NO. STAR DRIVE 150 PK *	PART NO. 5/16" HWH 225 PK	PART NO. STAR DRIVE 225 PK *	FIXTURE THICKNESS	STRAIGHT SHANK DRILL BIT PART NO.	DRILL BIT DESCRIPTION	CASE QTY *	BULK QTY
1/4" x 1-1/4"	BX51034	BX51102	BX51036	BX51104	3210 ^{BK}	3310 ^{BK}			24515C		0 - 1/4"	7230	3/16" x 3-1/2"	1000	3,000
1/4" x 1-3/4"	BX51040	BX51108	BX51042	BX51110	3220 ^{BK}	3320 ^{BK}			24520C		0 - 3/4"	7230	3/16" x 3-1/2"	1000	2,000
1/4" x 2-1/4"	BX51046	BX51114	BX51048	BX51116	3230 ^{BK}	3330 ^{BK}				24580C	1/2" - 1-1/4"	7240	3/16" x 4-1/2"	1000	1,000
1/4" x 2-3/4"	BX51052	BX51120	BX51054	BX51122	3240 ^{BK}	3340 ^{BK}	24530C				1" - 1-3/4"	7240	3/16" x 4-1/2"	1000	1,000
1/4" x 3-1/4"	BX51058	BX51126	BX51060	BX51128	3250 ^{BK}	3350 ^{BK}	24501C	24590C			1-1/2" - 2-1/4"	7250	3/16" x 5-1/2"	1000	750
1/4" x 4"			24345C	24397C							2-1/4" - 3"	7250	3/16" x 5-1/2"	500	750
1/4" x 5"			24400C	24411C	3280 ^{BK}	3380					3-1/4" - 4"	7260	3/16" x 6-1/2"	500	500
1/4" x 6"					3290 ^{BK}	3390					4-1/4" - 5"	7270	3/16" x 7-1/2"	100	250

Tapcon Anchors must be installed using all Buildex system components (Tapcon Anchors, Condrive Tools and Tapcon Drill Bits) in order to qualify for ITW Buildex system support.

* 1/4" Star Drive Tapcons use T-30 bit part #28001C

^{BK} Available in Bulk Pack Qty

Tapcon Black Anchors 1/4" and 3/16" Diameter



DESCRIPTION	PART NO. 1/4" HEX 100 PK	PART NO. 1/4" STAR DRIVE 100 PK *	PART NO. 3/16" STAR DRIVE 100 PK *	CASE QTY *
BLK 1/4" X 1-1/4"	3210B			1000
BLK 1/4" X 1-3/4"	3220B			1000
BLK 1/4" X 2-1/4"	3230B			1000
BLK 1/4" X 2-3/4"	3240B			1000
BLK 1/4" X 3-1/4"	3250B			1000
BLK 1/4" X 2-3/4"		3340B		1000
BLK 3/16" X 1-3/4"			3120B	1000
BLK 3/16" X 2-3/4"			3140B	1000

Tapcon Anchors must be installed using all Buildex system components (Tapcon Anchors, Condrive Tools and Tapcon Drill Bits) in order to qualify for ITW Buildex system support.

* 3/16" Star Drive Tapcons use T-25 bit part#28000C

Accessories

PART NUMBER	DESCRIPTION	BOX QTY
7001	Condrive Pro Installation Kit	4
BX51902	5/32 x 4-1/2 Tapcon Drill Bit	10
BX51906	3/16 x 4-1/2 Tapcon Drill Bit	10
BX51910	5/32 x 3-1/2 Tapcon Drill Bit	10
BX51912	3/16 x 3-1/2 Tapcon Drill Bit	10
BX51914	3/16 x 5-1/2 Tapcon Drill Bit	10
BX51916	5/32 x 5-1/2 Tapcon Drill Bit	10
11491C	3/16 x 7 SDS Plus Tapcon Drill Bit	10
11492C	5/32 x 7 SDS Plus Tapcon Drill Bit	10
28000C	2" T-25 Tapcon Star Bit	12
28001C	2" T-30 Tapcon Star Bit	12

Tapcon SDS Plus Drill Bits are specially designed to be compatible with Condrive Pro Installation Kit. Use the Tapcon bits and Condrive Pro together to install Tapcon anchors for optimal performance.

CONDRIVE PRO ADVANTAGES



- Works with all Impact Drivers, Rotary Hammers, Hammer Drills, Tapcon SDS and Carbide Straight Shank Bits.
- Fast and Easy: only one tool needed to drill and drive
- Recessed Hex Driver reduces overtorquing, head snapping, and spinouts
- Fits fully assembled in carrying pouch for easy storage

PERFORMANCE TABLES

Tension Values

(In Normal-Weight Concrete Lbs.)

ANCHOR DIAMETER	EMBEDMENT DEPTH	CONCRETE STRENGTH		
		2000 PSI	4000 PSI	5000 PSI
3/16	1"	600	650	800
	1-1/2"	1090	1090	1220
	1-3/4"	1450	1460	1730
1/4	1"	750	800	950
	1-1/2"	1380	1820	2170
	1-3/4"	2020	2380	2770

Tension and Shear Values

(In CMU 1" Embedment)

ANCHOR DIAMETER	TENSION (Lbs.)		SHEAR (Lbs.)	
	LIGHT WEIGHT	MEDIUM WEIGHT	LIGHT WEIGHT	MEDIUM WEIGHT
3/16	220	340	400	730
1/4	250	500	620	1000

For minimum edge distance and spacing distance, please refer to the ICC-ES report or Miami-Dade report for this product. Lightweight and medium-weight Concrete Masonry Units (CMU) were defined by ASTM C 90.

Shear Values

(In Normal-Weight Concrete Lbs.)

ANCHOR DIAMETER	EMBEDMENT DEPTH	CONCRETE STRENGTH		
		2000 PSI	4000 PSI	5000 PSI
3/16	1"	720	720	860
	1-1/2"	860	860	860
	1-3/4"	870	990	990
1/4	1"	900	1360	1440
	1-1/2"	1200	1380	1670
	1-3/4"	1670	1670	1670

NOTE: Indicated tension and shear failure values were obtained in tests conducted at CEL Consulting. Designated holding power depends on the quality of the masonry material, depth of embedment and proper hole size. These figures are offered only as a guide and are not guaranteed in any way by Illinois Tool Works Inc. The figures indicate **average ultimate tension and shear failure values**. A safety factor of 4:1 or 25% of ultimate value is generally accepted as a safe working load. However, reference should always be made to applicable codes for the specific safe working ratio. All values are based on close tolerance holes drilled with Buildex Tapcon® carbide drill bits. Performance of the Tapcon anchor may vary in extremely hard concrete aggregates. Consult your Buildex representative for further information.

As in the case with all applications, Buildex can only suggest typical fasteners for typical applications and that the connection design is the sole responsibility of the Building Design Engineer, Architect or otherwise responsible person charged with the design of the connection. For further product information, please contact the nearest Authorized Buildex Distributor or the Buildex Technical Service Department at 1-800-323-0720.

Tapcon+[®]

Seismic and Cracked Concrete Screw Anchors

**Finished Head,
Removable Anchor**



DESCRIPTION/SUGGESTED SPECIFICATIONS

Self-threading Anchors—

SPECIFIED FOR ANCHORAGE INTO CONCRETE REQUIRING CRACKED AND SEISMIC APPROVALS



Tapcon+ out performs traditional wedge anchor products, providing greater load capacity while reducing installation time by up to 50%, offering significant cost-in-place savings on the job site.

Tapcon+ is available with International Building Code (IBC) compliance and other third party listings for use in cracked concrete and seismic applications.

ADVANTAGES

In the Engineering Office:

- Leading steel strength in tension, shear, and seismic shear
- Outperforms wedge anchors in tension, shear, and anchor spacing
- 20% more holding power than wedge or sleeve anchors
- Approved for concrete in cracked, uncracked, and seismic conditions
- Simplicity of installation improves "buildability" on the job site
- Corrosion-resistance and long-lasting performance due to the innovative Blue Climaseal[®] coating

On the Job:

- More than 2x faster installation than wedge or sleeve anchors
- The ability to drive close to the edge with confidence
- Removable for temporary fixing
- Installs without hammering and precision torque wrench
- One fastening solution for multiple applications and materials

SELECTION CHART

DRILL BIT DIA. mm (in.)	ANCHOR OUTSIDE THREAD DIA. mm (in.)	EFFECTIVE LENGTH mm (in.)	ANCHOR HEAD (SOCKET SIZE) DIA. In.	MAX. THICKNESS MATERIAL TO BE FASTENED mm (in.)	PART NUMBER	QTY/ BOX	PART NUMBER BULK	QTY BULK BOX
6.4 (1/4)	7.9 (5/16)	57.2 (2-1/4)	3/8	6.4 (1/4)	-	-	3511407	600
6.4 (1/4)	7.9 (5/16)	76.2 (3)	3/8	25.4 (1)	-	-	3507407	100
9.5 (3/8)	11.7 (0.46)	(1-3/4)	9/16		11440C	10	-	-
9.5 (3/8)	11.7 (0.46)	(2-1/4)	9/16	6.4 (1/4)	11441C	10	-	-
9.5 (3/8)	11.7 (0.46)	76.2 (3)	9/16	12.7 (1/2)	11413C	10	3508407	300
9.5 (3/8)	11.7 (0.46)	101.6 (4)	9/16	38.1 (1-1/2)	11414C	10	3509407	200
9.5 (3/8)	11.7 (0.46)	127.0 (5)	9/16	63.5 (2-1/2)	11445C	10	-	-
9.5 (3/8)	11.7 (0.46)	152.4 (6)	9/16	88.9 (3-1/2)	11446C	10	-	-
12.7 (1/2)	14.0 (0.59)	76.2 (3)	3/4	25.4 (1)	11447C	10	-	-
12.7 (1/2)	14.0 (0.59)	101.6 (4)	3/4	50.8 (2)	11420C	10	3510207	100
12.7 (1/2)	14.0 (0.59)	127.0 (5)	3/4	76.2 (3)	11449C	10	-	-
12.7 (1/2)	14.0 (0.59)	152.4 (6)	3/4	101.6 (4)	11421C	10	3510407	100

APPLICATIONS



- Sill Plates
- Post Cap Connector
- Ledger Board
- Heavy Equipment
- Industrial Racking/Shelving
- Modular Walls
- Machinery

FEATURES



Induction hardened tip cuts into harder concrete, increases pullout.

Blue ClimaSeal® adds corrosion protection

Consult ICC-ESR 3699 for a full technical report. Available at www.itwredhead.ca

ACCESSORIES

PART NUMBER	DESCRIPTION	BOX QTY
11493C	1/4 x 7 SDS Plus Tapcon Drill Bit	10
11494C	3/8 x 8 SDS Plus Tapcon Drill Bit	10
11495C	1/2 x 10 SDS Plus Tapcon Drill Bit	10

APPROVALS/LISTINGS

ICC ESR-3699 – Cracked & Uncracked and Seismic approved
 City of Los Angeles (1/4" & 3/8" diameters)
 Florida Building Code Compliant

INSTALLATION STEPS

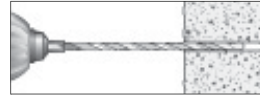

1. Drill a hole that is at least a 1/4" deeper than the anchor embedment.

Using
 Variable Speed Concrete Hammer Drill & Carbide Drill Bit
 1/4 x 7" Tapcon SDS+ Drill Bit (11493C) or
 3/8 x 8" Tapcon SDS+ Drill Bit (11494C) or
 1/2 x 10" Tapcon SDS+ Drill Bit (11495C) or
 Equivalent size ANSI Drill Bit

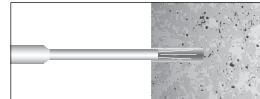

2. Using pressurized air or a vacuum, remove the drilling debris from the hole.

Using
 Air Compressor or Standard Vacuum Cleaner

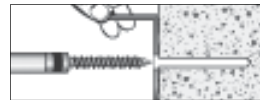

3. Drive Tapcon+ screw anchor through fixture (bracket, or attachment plate), until fully seated.

Using
 Six Point Impact Socket
 3/8" Socket for 1/4" Anchors
 9/16" Socket for 3/8" Anchors
 3/4" Socket for 1/2" Anchors

Impact Wrench
 115 Max ft-lbf for 1/4" Anchors
 200 Max ft-lbf for 3/8" Anchors
 345 Max ft-lbf for 1/2" Anchors

Strength Design Performance Values in Accordance to CSA 23.3-14

ITW RED HEAD TAPCON+ SCREW ANCHOR

DESIGN INFORMATION TESTED TO ICC-ES AC193 AND ACI 355.2, DEFINED IN ICC ESR-3699



TAPCON+ DESIGN INFORMATION

PARAMETER	Symbol	Units	Nominal Anchor Diameter				
			1/4"	3/8"	1/2"		
Anchor outer diameter	$d_a [d_o]^2$	mm.	6.4		9.5	12.7	
Drill bit specification		in	1/4" Tapcon+ bit	1/4" ANSI bit	3/8" ANSI bit	1/2" ANSI bit	
Minimum specified yield strength	f_y	MPa	689		689	689	
Minimum specified ultimate strength	f_{uta}	MPa	862		862	862	
Effective tensile stress area	$A_{se,N} [A_{se}]^6$	mm ²	30		63	119	
Effective shear stress area	$A_{se,V} [A_{se}]^6$	mm ²	30		63	119	CSA 23.3-14
Resistance modification factor, tension, steel failure modes	R	–			0.70		D5.3
Resistance modification factor, shear, steel failure modes	R	–			0.65		D5.3
Resistance factor for steel anchors	Φ_s	–			0.85		8.4.3
Factored steel resistance, tension	$N_{s,ar}$	kN	15.5		32.4	61.2	D.6.1.2
Factored steel resistance, shear	$V_{s,ar}$	kN	14.4		30.1	56.8	D.7.1.2
Factored steel resistance, seismic shear	$V_{s,ar,eq}$	kN	9.5		24.3	41.9	
Effectiveness factor for uncracked concrete	k_{uncr}	–	10		11.25	12.5	D.6.2.2
Effectiveness factor for cracked concrete	k_{cr}	–			7		D.6.2.2
Modification factor for resistance in tension to account for uncracked concrete	Ψ_c, N	–			1		D.6.2.6
Anchor category	–	–	1	2	1		
Material resistance factor for concrete	Φ_c	–			0.65		8.4.2
Strength reduction factor for tension and shear, concrete failure modes	R	Cond. A	1.15	1.00	1.15		D.5.3c
	R	Cond. B	1.00	0.85	1.00		D.5.3c
Modification Factor for concrete density	λ	–			1		8.6.5
Factored pullout resistance in 20 MPa uncracked concrete	$N_{pr, uncr}$	kN	6.6	5.6	Pullout does not control	Pullout does not control	D.6.3.2
Factored pullout resistance in 20 MPa cracked concrete	$N_{pr, cr}$	kN	2.7	2.3	5.4	Pullout does not control	D.6.3.3
Factored seismic pullout resistance in 20 MPa cracked concrete	$N_{pr, cr}$	kN	2.7	2.3	4.9	Pullout does not control	D.6.3.3

1. The data in this table was taken from ICC ESR-3699 and converted to be used in conjunction with the design provisions of CSA 23.3-14 or CSA 23.3-04, Chapter 8 and Annex D, as applicable.
2. Installation must comply with the manufacturers printed installation instructions and details described in the ICC ESR-3699 and this ITW Red Head catalog
3. The 1/4", 3/8", and 1/2" Tapcon+ carbon steel anchors are considered brittle steel elements
4. For all design cases, $\Psi_c, N = 1$. The appropriate effectiveness factor for cracked (k_{cr}) or uncracked concrete (k_{uncr}) must be used.
5. Condition B was assumed for the strength reduction factor for tension and shear (concrete failure modes). For cases where the presence of supplementary reinforcement in conformance with CSA 23.3-14 D.5.3 can be verified, the modification factor for condition A may be used
6. Where Pullout strength does not control anchor design, determine steel and concrete breakout capacities only.

Strength Design Performance Values in Accordance to CSA 23.3-14

ITW RED HEAD TAPCON+ SCREW ANCHOR



TAPCON+ INSTALLATION INFORMATION

PARAMETER	SYMBOL	UNITS	Nominal Anchor Diameter				
			1/4"	3/8"	1/2"		
Head Style	-	-	Hex Head	Hex Head	Hex Head		
Anchor Outer Diameter (Shank)	$d_a [d_o]^{12}$	mm. (in.)	6.4 (0.25)	9.7 (0.38)	12.7 (0.50)		
Nominal carbide bit diameter	d_{bit}	in.	1/4" Tapcon+ or 1/4" ANSI Bit	3/8" ANSI Bit	1/2" ANSI Bit		
Minimum base plate clearance hole diameter	d_h	mm. (in.)	9.7 (0.38)	12.7 (0.50)	16.0 (0.63)		
Effective embedment depth	h_{ef}	mm. (in.)	36.8 (1.45)	45.2 (1.78)	33.5 (1.32)	55.1 (2.17)	76.7 (3.02)
Minimum nominal embedment depth	h_{nom}	mm. (in.)	50.8 (2)	63.5 (2-1/2)	50.8 (2)	76.2 (3)	101.6 (4)
Minimum hole depth	h_o	mm. (in.)	57.2 (2-1/4)	69.9 (2-3/4)	57.2 (2-1/4)	82.6 (3-1/4)	108 (4-1/4)
Minimum concrete member thickness	h_{min}	mm. (in.)	101.6 (4)	101.6 (4)	101.6 (4)	152.4 (6)	
Critical edge distance	c_{ac}	mm. (in.)	63.5 (2-1/2)	114.3 (4-1/2)	76.2 (3)	101.6 (4)	127.0 (5)
Minimum anchor spacing	s_{min}	mm. (in.)	76.2 (3)	76.2 (3)	76.2 (3)	88.9 (3-1/2)	76.2 (3)
Minimum edge distance	c_{min}	mm. (in.)	38.1 (1-1/2)	38.1 (1-1/2)	63.5 (2-1/2)	44.5 (1-3/4)	63.5 (2-1/2)
Maximum installation torque	$T_{inst, max}$	ft-lb	20	50	70		
Maximum installation torque	$T_{impact, max}$	ft-lb	115	200	345		

1. Use ANSI carbide tipped hammer drill bits made in accordance with ANSI B212.15-1994 to install anchors.
2. $T_{inst, max}$ applies to installations using a calibrated torque wrench



FACTORED STEEL RESISTANCE FOR TAPCON+ CARBON STEEL ANCHORS

Nominal Anchor Diameter	Effective Emb. Depth mm. (in.)	Tensile, kN (lbf)	Shear, kN (lbf)	Seismic shear, kN (lbf)
1/4	37 (1-4/9)	15.5 (3495)	14.4 (3245)	9.5 (2145)
3/8	45 (1-7/9)	32.4 (7290)	30.1 (6770)	24.3 (5460)
1/2	34 (1-1/3)	61.2 (13760)	56.8 (12775)	41.9 (9425)
	55 (2-1/6)			
	77 (3)			

1. The 1/4", 3/8", and 1/2" Tapcon+ carbon steel anchors are considered brittle steel elements
2. Tension values calculated according to Clause D6.1.2 in CSA A23.3-14 Annex D
3. Shear values calculated according to Clause D7.1.2 in CSA A23.3-14 Annex D
4. Seismic shear was calculated by reducing V_{sar} based on correlation between V_{sa} and V_{eq} from the ICC ESR-3699

Strength Design Performance Values in Accordance to CSA 23.3-14

ITW RED HEAD TAPCON+ SCREW ANCHOR



FACTORED CONCRETE BREAKOUT/PULLOUT, TENSION kN (lbf)

Nominal Anchor Diameter (in.)	Effective Embedment Depth (in.)	Nominal Embedment Depth mm. (in.)	Concrete Compressive Strength (Uncracked)					Concrete Compressive Strength (Cracked)				
			20 MPa (2900)	25 MPa (3625)	30 MPa (4350)	40 MPa (5800)	50 MPa (7250)	20 MPa (2900)	25 MPa (3625)	30 MPa (4350)	40 MPa (5800)	50 MPa (7250)
1/4	37 (1-4/9)	51 (2)	5.6 (1250)	6.2 (1395)	6.8 (1530)	7.9 (1765)	8.8 (1975)	2.3 (510)	2.5 (570)	2.8 (625)	3.2 (720)	3.6 (805)
3/8	45 (1-7/9)	64 (2-1/2)	9.9 (2235)	11.1 (2500)	12.2 (2735)	14.1 (3160)	15.7 (3535)	5.4 (1215)	6.0 (1360)	6.6 (1490)	7.6 (1720)	8.6 (1920)
1/2	34 (1-1/3)	51 (2)	7.1 (1585)	7.9 (1775)	8.6 (1940)	10.0 (2245)	11.2 (2505)	4.0 (890)	4.4 (995)	4.8 (1090)	5.6 (1255)	6.2 (1405)
	55 (2-1/6)	76 (3)	14.9 (3345)	16.6 (3735)	18.2 (4095)	21.0 (4725)	23.5 (5285)	8.3 (1870)	9.3 (2095)	10.2 (2295)	11.8 (2645)	13.2 (2960)
	77 (3)	102 (4)	24.4 (5490)	27.3 (6135)	29.9 (6720)	34.5 (7760)	38.6 (8675)	13.7 (3075)	15.3 (3435)	16.7 (3765)	19.3 (4345)	21.6 (4860)

1. Linear interpolation between embedment depths and concrete compressive strength is not permitted.
2. Single anchor with no spacing, edge distance, and concrete thickness factors included. Apply these factor according to project condition and compare to steel values to determine anchor strength for design.
3. Tabular values are for normal weight concrete only. For different concrete densities, apply modification factors according to CSA 23.3-14 8.6.5
4. Tabular values are for static loads only. For seismic tension refer to section 4.1.8 of the ICC ESR-3699.
5. Values are for Condition B in conformance with CSA 23.3-14 D.5.3
6. ANSI carbide bit drilling was assumed for all diameters. If using a 1/4" Tapcon+ drill bit, cracked and uncracked pullout of 1/4" Tapcon+ can be multiplied by 1.18

FACTORED CONCRETE PRYOUT/STEEL, RESISTANCE, SHEAR kN (lbf)

Nominal Anchor Diameter (in.)	Effective Embedment Depth mm. (in.)	Nominal Embedment Depth mm. (in.)	Concrete Compressive Strength (Uncracked)					Concrete Compressive Strength (Cracked)				
			20 MPa (2900)	25 MPa (3625)	30 MPa (4350)	40 MPa (5800)	50 MPa (7250)	20 MPa (2900)	25 MPa (3625)	30 MPa (4350)	40 MPa (5800)	50 MPa (7250)
1/4	37 (1-4/9)	51 (2)	5.5 (1240)	6.2 (1395)	6.8 (1530)	7.8 (1755)	8.7 (1965)	2.3 (870)	4.3 (970)	4.7 (1065)	5.5 (1230)	6.1 (1375)
3/8	45 (1-7/9)	64 (2-1/2)	9.9 (2235)	11.1 (2500)	12.2 (2735)	14.1 (3160)	15.7 (3535)	6.2 (1390)	6.9 (1555)	7.6 (1705)	8.7 (1965)	9.5 (2200)
1/2	34 (1-1/3)	51 (2)	7.1 (1585)	7.9 (1775)	8.6 (1940)	10.0 (2245)	11.2 (2505)	4.0 (890)	4.4 (995)	4.8 (1090)	5.6 (1255)	6.2 (1405)
	55 (2-1/6)	76 (3)	14.9 (3345)	16.6 (3735)	18.2 (4095)	21.0 (4725)	23.5 (5285)	8.3 (1870)	9.3 (2095)	10.2 (2295)	11.8 (2645)	13.2 (2960)
	77 (3)	102 (4)	48.8 (10975)	54.6 (12270)	56.8 (12775)	56.8 (12775)	56.8 (12775)	27.3 (6145)	30.6 (6870)	33.5 (7530)	38.7 (8695)	43.2 (9720)

1. Linear interpolation between embedment depths and concrete compressive strength is not permitted.
2. Single anchor with no spacing, edge distance, and concrete thickness factors included. Apply these factor according to project condition and compare to steel strength values to determine anchor strength for design.
3. Tabular values are for normal weight concrete only. For different concrete densities, apply modification factors according to CSA 23.3-14 8.6.5
4. Tabular values are for static loads only. For seismic shear compare values in this table with steel strength values.
5. Values are for Condition B in conformance with CSA 23.3-14 D.5.3

E-Z Drywall Anchors

*The Original!
Fast and Easy
Self-Drilling
Anchors*



DESCRIPTION/SUGGESTED SPECIFICATIONS

Drywall Anchor Applications—



**E-Z Anchor
Self-Drilling
Anchor**

The E-Z Anchor is a one-piece self-drilling anchor designed for optimal holding performance in gypsum wallboard. Available in zinc or high strength engineered plastic (non-conductive). Ideal anchor for 3/8", 1/2" and 5/8" gypsum wallboard.

ADVANTAGES

- No hole preparation necessary; pre-drills own small precise hole in gypsum wallboard.
- Replaces plastic plugs and toggles.
- Deep thread design provides strong engagement in 3/8" 1/2" and 5/8" gypsum wallboard.
- Installs quickly and easily with a phillips screw-driver or square drive bit.
- Full range of anchors to cover all wall fastening applications.
- Available in corrosion resistant, non-conductive white nylon.
- Can be easily backed-out.
- Low profile head.
- Single point designs for clean cutting installation.

E-Z Anchors



E-Z Drywall Anchors

APPLICATIONS

Electrical Fixtures	Plaques and Awards	Smoke Detectors
Thermostats	Closet Organizers	Clocks
HVAC Fixtures	Coat Racks	Kitchen Accessories
Plumbing Fixtures	Curtain Rods	Doorbells
Bathroom Accessories	Signs	Telecommunications Equipment
Shelving and Supports	Bulletin Boards	Chalk Boards
Mirrors	Control Systems	Remote Control Boxes
Picture Frames	Decorative Wall Hangings	
Brackets	Office Material Holders	

SPECIFICATIONS

Material Zinc and Nylon

Drilling Capacity 3/8", 1/2" and 5/8" gypsum wallboard

PERFORMANCE TABLE

E-Z Anchors

DRYWALL THICKNESS	HOLDING WEIGHT (lbs.) Gypsum Board Thickness		
	3/8"	1/2"	5/8"
EZ Mini and Mini Twist-N-Lock	30	40	50
E-Z Anchor and EZ Stud Solver	40	50	75
Twist-N-Lock	65	75	80

These performance values are averages obtained under laboratory conditions. Note that these values will change depending on age, moisture content and surface treatment of the drywall (gypsum) material. Appropriate safety factors should be applied to these values for design purposes.

SELECTION CHART

E-Z Anchors

PART NUMBER WITH SCREWS	PART NUMBER WITHOUT SCREWS	DESCRIPTION	MATERIAL	MAXIMUM FIXTURE THICKNESS	ACCOMMODATES SHEETS METAL SCREW SIZE	BOX QTY	CASE QTY	BULK QTY
6411L	6400L ^S	Mini Twist-N-Lock	Nylon	3/4"	#6	100	1000	10,000
6411M	6400M	E-Z Mini	Zinc	3/4"	#6, #7, #8	100	1000	
6511T	6400	E-Z Ancor	Zinc	3/4"	#6, #7, #8	100	1000	
6511	6500	EZ Stud Solver	Zinc	3/4"	#8	100	1000	
6411P	6400P ^B	E-Z Twist N Lock	Nylon	3/4"	#8	100	1000	4,500

^B Available in Bulk Pack Qty

INSTALLATION INSTRUCTIONS

LIGHT DUTY & MEDIUM DUTY E-Z ANCORS

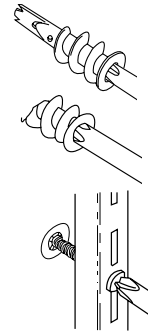

1. Place #2 Phillips screwdriver into recess of E-Z Zinc, E-Z Lite, E-Z Mini, E-Z Stud Solver, Twist-N-Lock, or E-Z Plastic Plus.
2. Press into drywall while turning the anchor clockwise until it is seated flush with wall.
3. Place fixture in position over installed E-Z Zinc, E-Z Lite, E-Z Mini, E-Z Stud Solver, Twist-N-Lock, or Plastic Plus. Insert screw with screw driver. Tighten fixture in place.



**ROCK-ON. BACKER-ON.
CEMENT BOARD SCREWS**

**Cement Board
and Fiber Cement
Backerboard
Fasteners**



DESCRIPTION

**Patented Cement Boards Screws with
Serrated Head for Flush Seating**

Backer-On® cement screws are designed for attaching Hardie-Backer® cement board and Rock-On® cement board screws are designed for attaching Durock® cement board to wood or light gauge steel studs. Patented design and ANSI compliant making these perfect for use in high moisture areas such as bathrooms and kitchen.

ADVANTAGES

- Serrated head designed to drive flush even at an angle
- Star drive with T-25 bit and Stikfit™ for easy one-handed installation and eliminates cam-outs
- Hi-Lo threads for Rock-On and Single Threads for Backer-On are designed for quick and smooth drives into cement boards
- Sharp points offer immediate pick-up and eliminates pre-drilling
- Patented design allows attaching close to edge on cement board, drastically reducing fractures or blow outs
- Corrosion resistance with Climacoat finish will prevent rust from bleeding into tile
- Comply with ANSI A108.11 standards as specified by cement board manufacturers – alternative options such as roofing nails and generic drywall screws are typically not specified by manufacturers nor are they ANSI compliant

INSTALLATION INSTRUCTIONS

1. A standard screwgun with a depth sensitive nosepiece should be used to install cement board fasteners. For optimal fastener performance, use a screwgun with adjustable depth of drive and variable RPM (0-2000).
2. Adjust the screwgun nosepiece to properly seat the fastener.
3. Use enclosed T-25 Star Drive bit to drive in the cement board - worn or damaged bit tips should be replaced.
4. The fastener is fully seated when the head is flush with the work surface.
5. Overdriving may result in torsional failure of the fastener or stripout of the substrate.
6. Steel stud attachment - Fastener must penetrate a minimum 3/8" beyond steel for optimal performance"
7. Wood stud attachment - Fastener must penetrate 1" into wood stud or beyond plywood for optimal performance"

APPLICATIONS

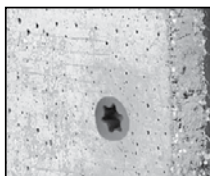

Cement-type boards or any dense sheathings to steel or wood studs.

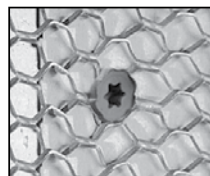

Wire lath to steel or wood studs.

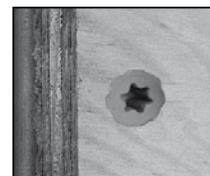

Plywood to steel or wood studs.

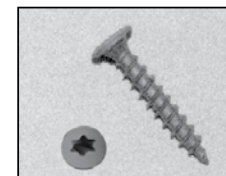

Hardie Fiber Cement Backerboard

Rock-On, Backer-On Fasteners

SELECTION CHART

Rock-On Backer-On Fasteners



PART NUMBER	LENGTH	HEAD STYLE	MATERIAL THICKNESS	BOX QTY	APPLICATIONS
23401C	1-1/4"	T-25 (Bit Included)	1/4" Cement Board	185	- Backer Board to wood or light gauge steel 26-20 gauge
23406C	1-1/4"	T-25 (Bit Included)	1/4" Cement Board	750	
23411C	1-5/8"	T-25 (Bit Included)	1/2" Cement Board	140	

Accessories

PART NUMBER	DESCRIPTION	BOX QTY
24000C	T-25 Stikfit Bit (2/PK)	12 Packs

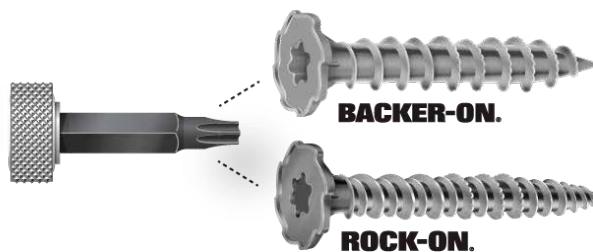

PERFORMANCE TABLES

Sheet Steel Gauges

GAUGE NO.	12	14	16	18	20	22	24	26
Nominal Decimal Equivalent (Inch)	.105	.075	.060	.048	.036	.030	.024	.018

Pullout Values

FASTENER	STEEL GAUGE (Lbs.)							
	26	24	22	20	18	16	14	12
Hi-Lo	163	242	314	370	----	----	----	----
Backer-On	271	371	457	615	----	----	----	----

Wood Embedment

#2 SPF 2 x 4	1/2"	3/4"	1"	1-1/4"
Hi-Lo	223	312	555	676
Backer-On	----	436	780	----

The values listed are ultimate averages achieved under laboratory conditions and apply to Buildex manufactured fasteners only. Appropriate safety factors should be applied to these values for design purposes.

Gridmate® BR

Plastic Insulation Fasteners



DESCRIPTION/ADVANTAGES

Fastening Insulation To Concrete—

- Textured head allows for coverage of stucco.
- Non cold-conductive.
- Made from strong Polypropylene.
- Fins provided high holding power.
- Non Corrosive.
- Easy to install.

APPLICATIONS

- All Polymer Modified (PM) Systems.
- Modified Stucco Systems.
- Exapnded lath over EPS, XPS or ISO rigid insulation.
- Fiberglass fabric over rigid insulation.
- Wire mesh over rigid insulation.
- Attaching rigid insulation to masonry or concrete.

SELECTION CHART

Gridmate BR Anchor



PART NUMBER	REFERENCE NUMBER	DESCRIPTION	HOLE DIAMETER	MAXIMUM GRIP	BOX QTY
56040	56040	2-3/4"	5/16"	1-1/2"	250
56050	56050	3-1/2"	5/16"	2-1/2"	200
56060	56060	4-3/8"	5/16"	3-1/4"	200
56070	56070	5-1/4"	5/16"	4"	100

Washer diameter is 1-3/8"

PERFORMANCE TABLE

Gridmate BR

BASE MATERIAL	EMBEDMENT	ULTIMATE PULLOUT
25 MPA Concrete	1-1/8"	113 lbs.
Concrete Block	1-1/8"	113 lbs.
Brick	1-1/8"	113 lbs.

8 fasteners per 4' x 8' sheet required.

National Headquarters

120 Travail Road
Markham, Ontario, L3S 3J1

Tel: 905-471-7403
800-387-9692

Fax: 905-471-7208
800-668-8688

Technical and Customer Service Support

Tel: 800-387-9692

Fax: 800-668-8688

Regional Warehouses

- Markham, Ontario
- Coquitlam, British Columbia
- Calgary, Alberta

Ramset, T4, T3, T3Cup, Trakfast, GypFast, Mastershot, Triggershot, Hammershot, PowerPoint, TE Pin and Climacoat are trademarks of Illinois Tool Works, Inc.

A7+, Dynabolt, Hammer-Set, LDT, Multi-Set II, Poly Set, Red Head, Redi-Drive, S7, Striker, and Trubolt are trademarks of ITW Red Head and Illinois Tool Works, Inc.

Teks, TruGrip GT, Scots, Maxiseal, Dek-Cap, Tapcon SG, Tapcon, Maxi-Set Tapcon, Condrive, E-Z Anchor, Twist-N-Lock, E-Z Lite, E-Z Mini, Stud Solver, Hi-Lo, S-12, Backer-On, Rock-On, DeckKing, Dec-U-Drive, Dek-Cap, Grid-Mate, Grid-Mate, PB, Climaseal, Spex, Climacoat, UltraShield, Climashield and Building Ideas That Work are trademarks of ITW Buildex and Illinois Tool Works, Inc.

Sammys, Sammy X-Press, Sammy X-Press It, Sammy X-Press Swivel, Sammy X-Press Sidewinder, Tapcon, Sammy Saddle, Speedy Pole Tool, Spot-Rite Level, and Truss-T Hanger are trademarks of ITW Buildex and Illinois Tool Works, Inc.

The term "Paslode" is a trademark and the Paslode logo and all related product and service names, designs and slogans are Paslode trademarks. Paslode, RounDrive, Impulse, Positive Placement are registered trademarks, PowerFramer and quicklode are trademarks of Illinois Tool Works.

R4, RSS, Kameleon, Fin/Trim, RT Composite, Low Profile Cabinet, Pheinox, Top Star, VWS, Caliburn, and The GRK Fasteners Canada Ltd. and all associated designs and logos are trademarks of GRK Fasteners Canada Ltd., used under license.

Hilti is a registered trademark of Hilti, Corp.

DensGlass is a registered trademark of Georgia Pacific Building Products.

Dekstrip, Dektite, Retrofit Dektite, and Dektite are registered trademarks of Deks Industries Pty Ltd.

Phillips Square-driv is a registered trademark of the Phillips Screw Company.

Take Advantage of these Contractor Services from ITW Construction Products Canada

From job sites to engineering firms, from Safety Seminars to on-site services, we hope you take advantage of our many contractor services— at no charge! After all, it's one thing to offer the quality products you need to do your job. It's another to provide you with superior service, engineering expertise and total product support.

At ITW Construction Products Canada, we are proud of the partnerships we have built through the years with our distributor network and contractors. Thanks to quality products, innovative services and on-time delivery, we will continue to build new relationships and strengthen existing ones today... and into the next century.

- Factory representatives with years of training and service experience will go out to your job site to provide you with product, service and technical assistance.
- We provide architects and engineers with complete submittal packages which gives them the technical data needed to specify ITW Construction Products Canada products. Contact your ITW Construction Products Canada Distributor or your nearest Customer Service location to request submittal packages.

Technical Application Assistance:

- Our staff of application specialists are ready to assist you with any type of application or code approval question during any phase of your project. Call 1-800-387-9692 between 8:00 a.m. and 5:00 p.m. EST, Monday through Friday.

Distributed By



The information and recommendations in this document are based on the best information available to us at the time of preparation. We make no other warranty, expressed or implied, as to its correctness or completeness, or as to the results or reliance of this document.